

# SMD Inductors(Coils) For Power Line(Wound, Magnetic Shielded)

Conformity to RoHS Directive

## VLCF Series VLCF5020

### FEATURES

- Miniature size  
Mount area: 5×5mm  
Height: 2.0mm max.
- Generic use for portable DC to DC converter line
- High magnetic shield construction should actualize high resolution for EMC protection.
- Available for automatic mounting in tape and reel package.
- The products do not contain lead and support lead-free soldering.

### APPLICATIONS

DC to DC converters for DVC, DSC, PDA, MD, LCD displays, HDDs, etc.

### SHAPES AND DIMENSIONS

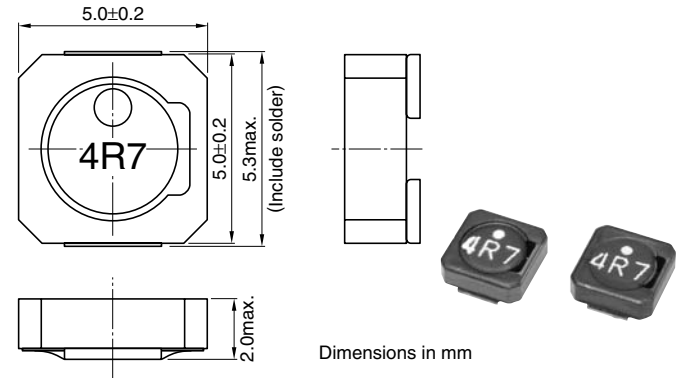

### RECOMMENDED PC BOARD PATTERN

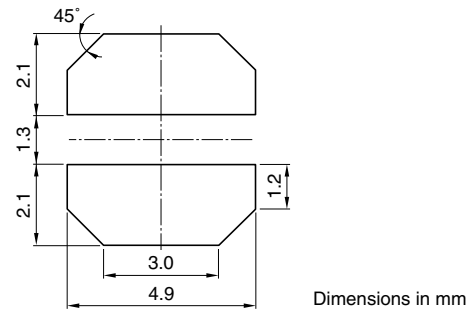

### ELECTRICAL CHARACTERISTICS

Part No.	Inductance (μH)	Inductance tolerance	Test frequency (kHz)	DC resistance(Ω)		Rated current(A)*	
				max.	typ.	Based on inductance change max.	Based on temperature rise typ.
VLCF5020T-1R8N2R0	1.8	±30%	100	0.059	0.049	2.07	2.75
VLCF5020T-2R7N1R7	2.7	±30%	100	0.071	0.058	1.76	2.51
VLCF5020T-3R3N1R6	3.3	±30%	100	0.083	0.069	1.6	2.31
VLCF5020T-4R7N1R4	4.7	±30%	100	0.096	0.079	1.4	2.15
VLCF5020T-6R8N1R1	6.8	±30%	100	0.122	0.102	1.11	1.9
VLCF5020T-100MR87	10	±20%	100	0.182	0.151	0.87	1.56
VLCF5020T-150MR71	15	±20%	100	0.256	0.214	0.71	1.3
VLCF5020T-220MR58	22	±20%	100	0.373	0.311	0.58	1.1
VLCF5020T-330MR48	33	±20%	100	0.522	0.435	0.48	0.92
VLCF5020T-470MR40	47	±20%	100	0.748	0.623	0.40	0.77
VLCF5020T-101MR27	100	±20%	100	1.581	1.375	0.27	0.52

\* Rated current: Value obtained when current flows and the temperature has risen to 40°C or when DC current flows and the nominal value of inductance has fallen by 30%, whichever is smaller.

- Operating temperature range: -40 to +105°C (Including self-temperature rise)

• Conformity to RoHS Directive: This means that, in conformity with EU Directive 2002/95/EC, lead, cadmium, mercury, hexavalent chromium, and specific bromine-based flame retardants, PBB and PBDE, have not been used, except for exempted applications.

• All specifications are subject to change without notice.